

KLASSIK ZA OBLJENOG KROJA

- Koristite naš najširi spektar primena do sada da kreirate sopstvena krovna rešenja po meri
- Idealno i za renoviranje i za novogradnju
- Elegantno svedeni, naši večni oblici stvaraju klasično lepe krovove
- Dodajte individualnost krovnim pejzažima
- Širok spektar boja i završnih obrada

TEHNIČKI PODACI

Dimenzije (pribl.)	180 x 380 x 14 mm
Maks. pokrivena širina (pribl.)	180 mm
Min. letvanje (pribl.)	145 mm
Pros. pokrivena dužina pribl.	155 mm
Maks. letvanje (pribl.)	165 mm
Min. potreban crep (pribl.)	33.6 kom./m ²
Prosečno potreban crep (pribl.)	36 kom./m ²
Jedinična težina (pribl.)	1.8 kg/komad
Težina po m ² (pribl.)	64.8 kg/m ²
Težina po paleti (pribl.)	927 kg
Komada po mini pakovanju	8 komad
Kom. po paleti	480 komad



LAF-/FLA VREDNOSTI

LAF-/FLA VREDNOSTI U MM SA FALCOM ZA 30X50 LETVE										
potreban grebeni crep (pribl.)	DN	20°	25°	30°	35°	40°	45°	50°	55°	60°
BG 3.0 pak/m	LAF	90	85	80	80	80	75	75	80	85
BMK 3.0 pak/m	LAF			60	60	55	55	50	50	45
BMZ 2.7 pak/m	LAF	90	85	80	75	75	75	75	80	80
BM 3.0 pak/m	LAF	90	85	80	80	80	75	75	85	85
BZ 3.0 pak/m	LAF	90	85	80	75	75	75	75	80	

LAF-/FLA VREDNOSTI U MM SA FALCOM ZA 40X60 LETVE										
potreban grebeni crep (pribl.)	DN	20°	25°	30°	35°	40°	45°	50°	55°	60°
BG 3.0 pak/m	LAF	85	80	75	75	75	65	60	65	70
BMK 3.0 pak/m	LAF			55	55	50	45	35		
BMZ 2.7 pak/m	LAF	85	80	75	70	70	65	60	65	65
BM 3.0 pak/m	LAF	85	80	75	75	75	65	60	70	70
BZ 3.0 pak/m	LAF	85	80	75	70	70	65	60	65	

LAF-/FLA VREDNOSTI U MM SA FALCOM ZA 50X50 LETVE										
potreban grebeni crep (pribl.)	DN	20°	25°	30°	35°	40°	45°	50°	55°	60°
BG 3.0 pak/m	LAF	80	75	70	65	65	55	50	55	55
BMK 3.0 pak/m	LAF			50	45	40	35	25		
BMZ 2.7 pak/m	LAF	80	75	70	60	60	55	50	55	50
BM 3.0 pak/m	LAF	80	75	70	65	65	55	50	60	55
BZ 3.0 pak/m	LAF	80	75	70	60	60	55	50	55	



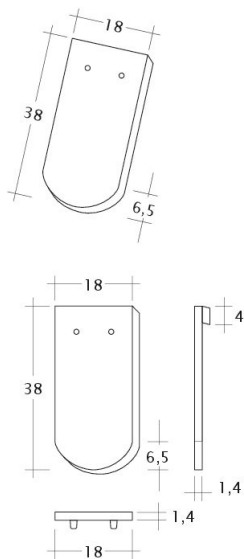

Tehnički crtež proizvoda KLASSIK 1-1

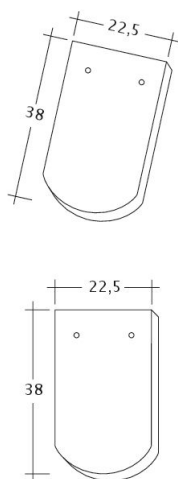

Tehnički crtež proizvoda KLASSIK 1-1-4



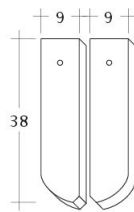
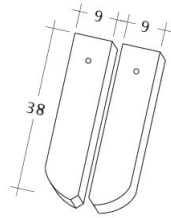

Tehnički crtež proizvoda KLASSIK 1-2

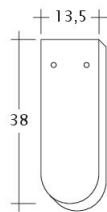
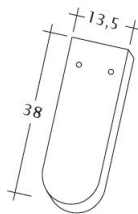

Tehnički crtež proizvoda KLASSIK 3-4



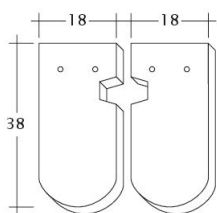
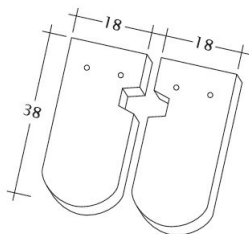

Tehnički crtež proizvoda KLASSIK Ausschnitt-LUEFTZ

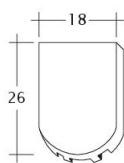
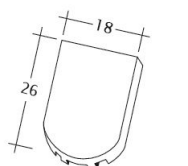

Tehnički crtež proizvoda KLASSIK FALZ



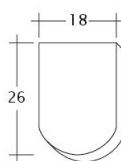
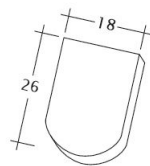

Tehnički crtež proizvoda KLASSIK Firstanschluss

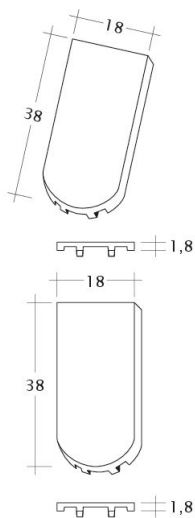

Tehnički crtež proizvoda KLASSIK Flaechenluefter



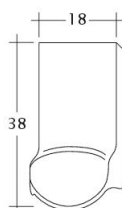
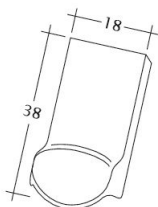

Tehnički crtež proizvoda KLASSIK LUEFTZ

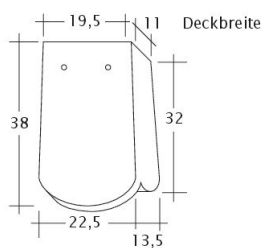
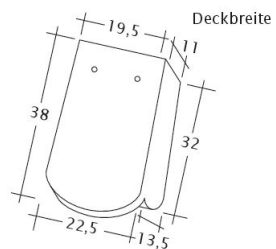

Tehnički crtež proizvoda KLASSIK OG-1-1-4



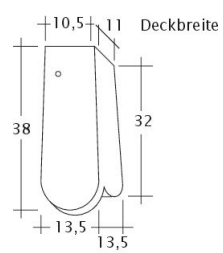
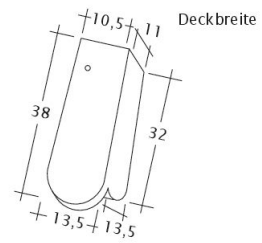

Tehnički crtež proizvoda KLASSIK OG-3-4

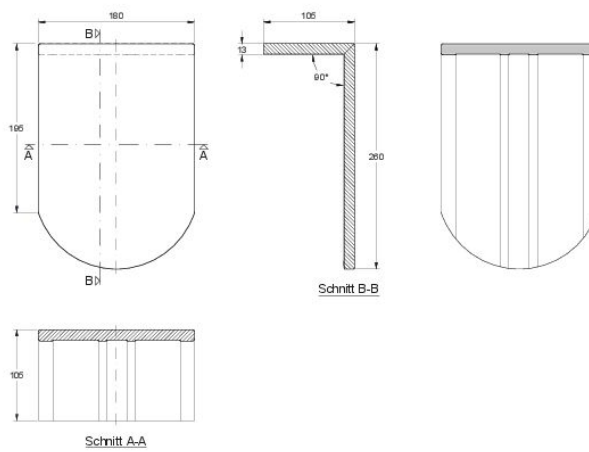

Tehnički crtež proizvoda KLASSIK PULT-kurz



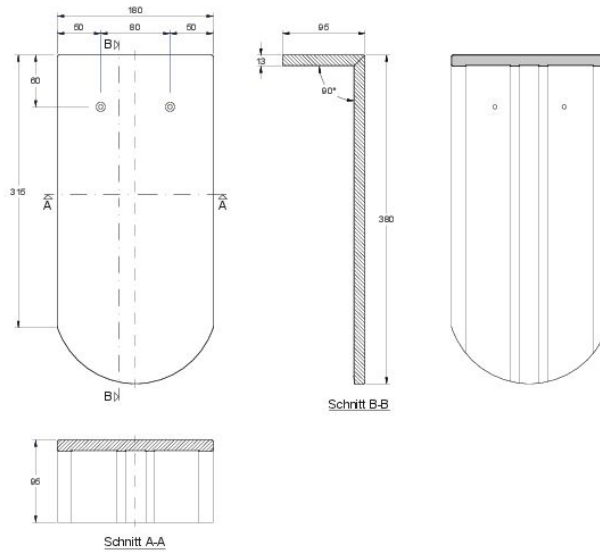

Tehnički crtež proizvoda KLASSIK PULT-lang

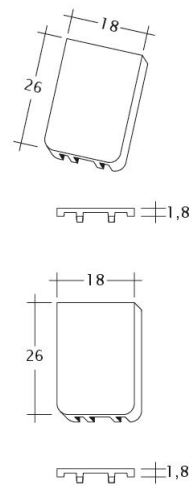

Tehnički crtež proizvoda KLASSIK Traufleufter



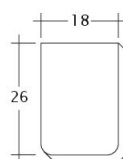
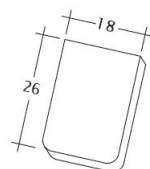

Tehnički crtež proizvoda KLASSIK Traufziegel

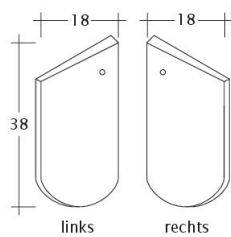
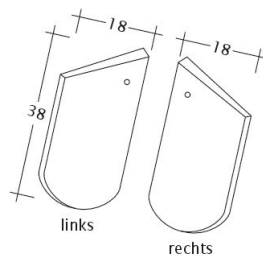

Tehnički crtež proizvoda KLASSIK Unterlaeufer



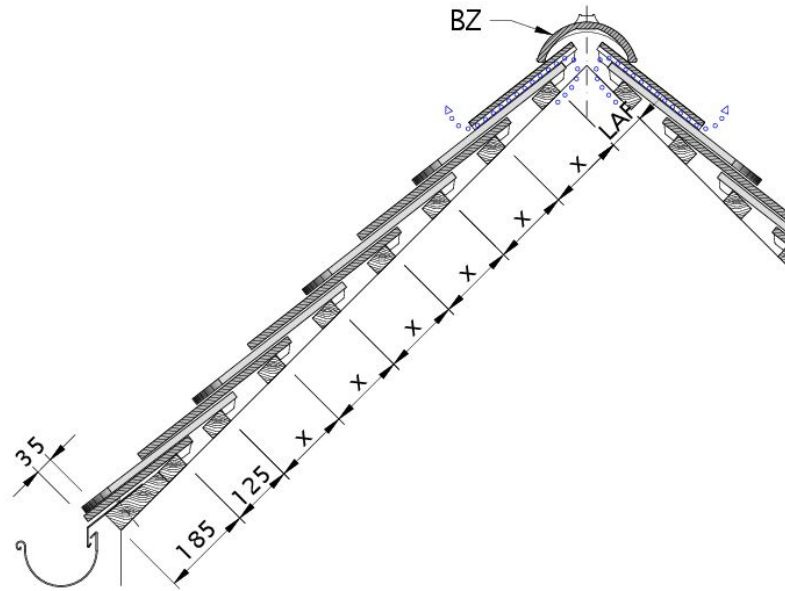

Tehnički crtež proizvoda KLASSIK DQF DQD-1

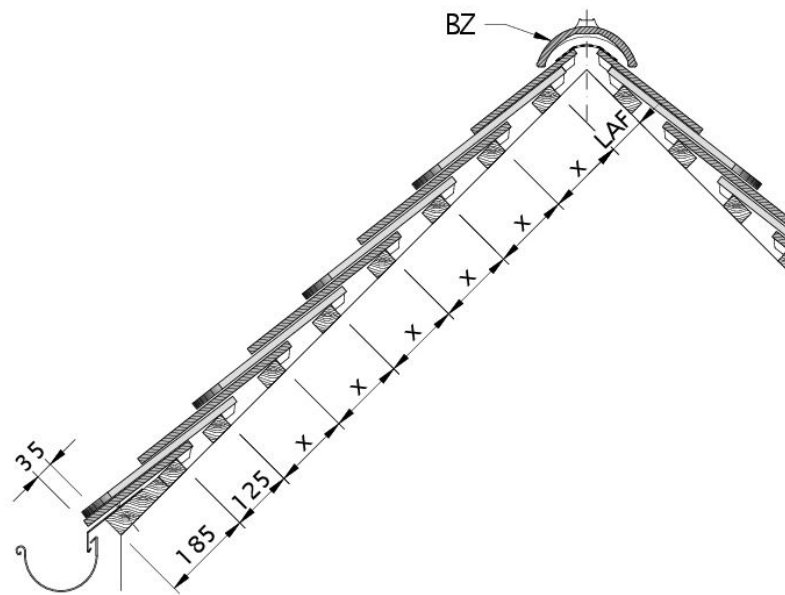

Tehnički crtež proizvoda KLASSIK DQF DQD-2



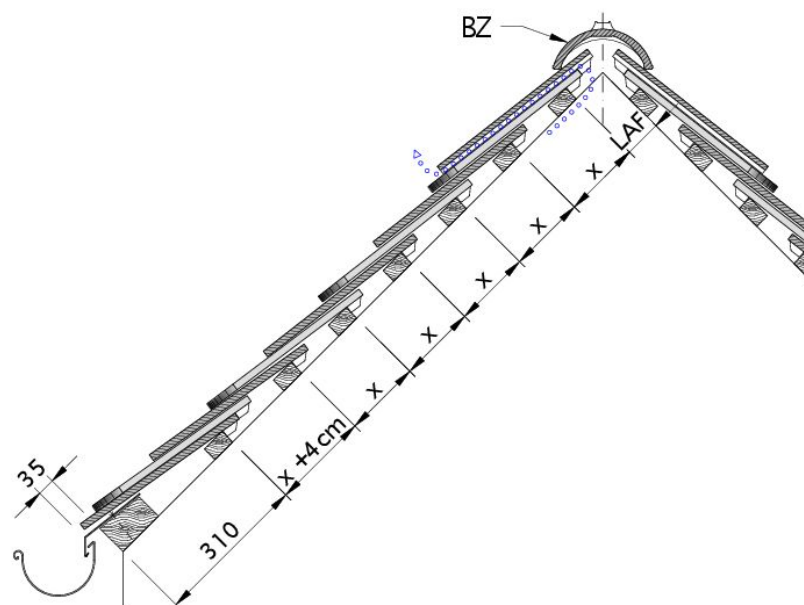

Tehnički crtež proizvoda KLASSIK DQF DQD-3

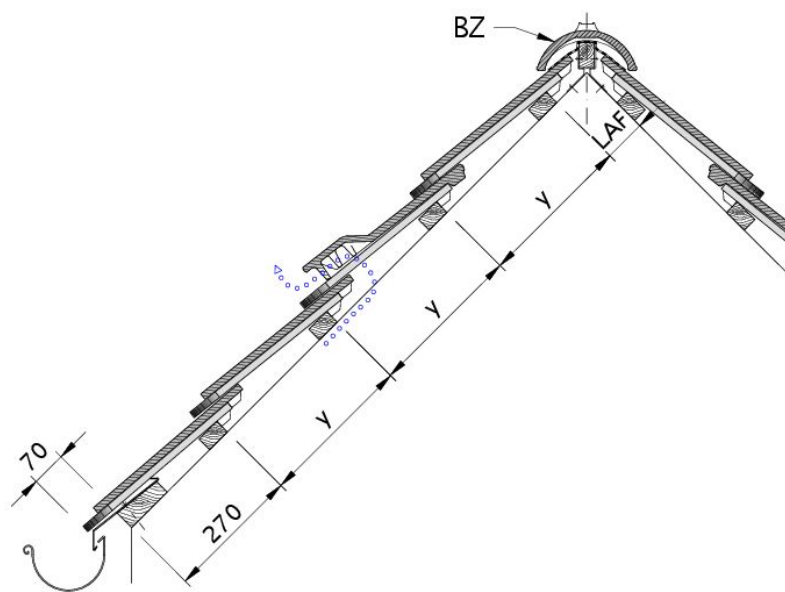

Tehnički crtež proizvoda KLASSIK DQF DQK-1



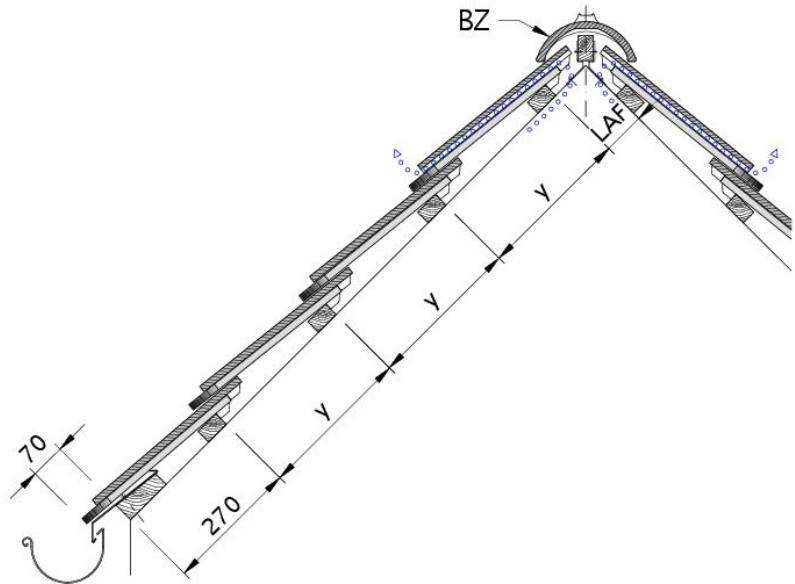

Tehnički crtež proizvoda KLASSIK DQF DQK-2

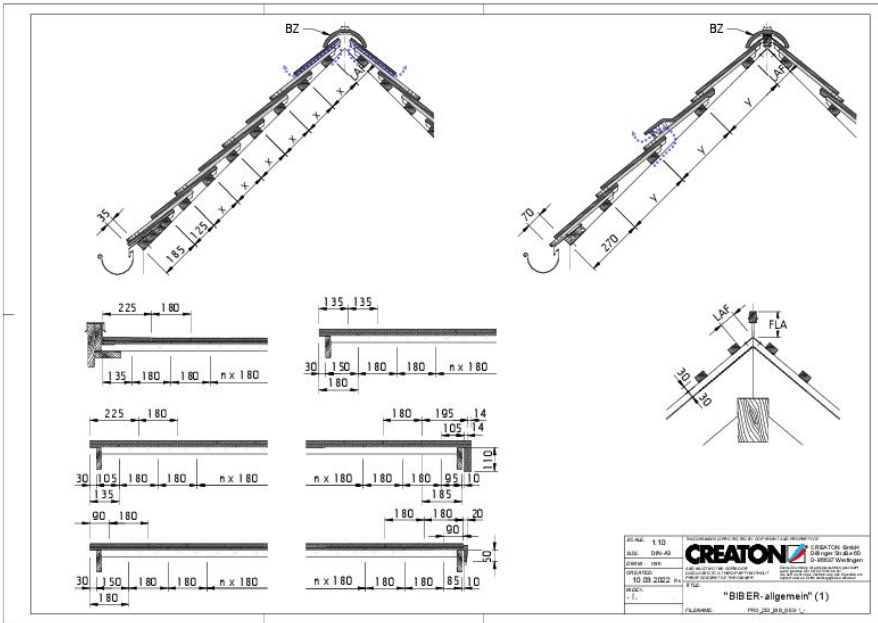

Drawing KLASSIK general view GES-1



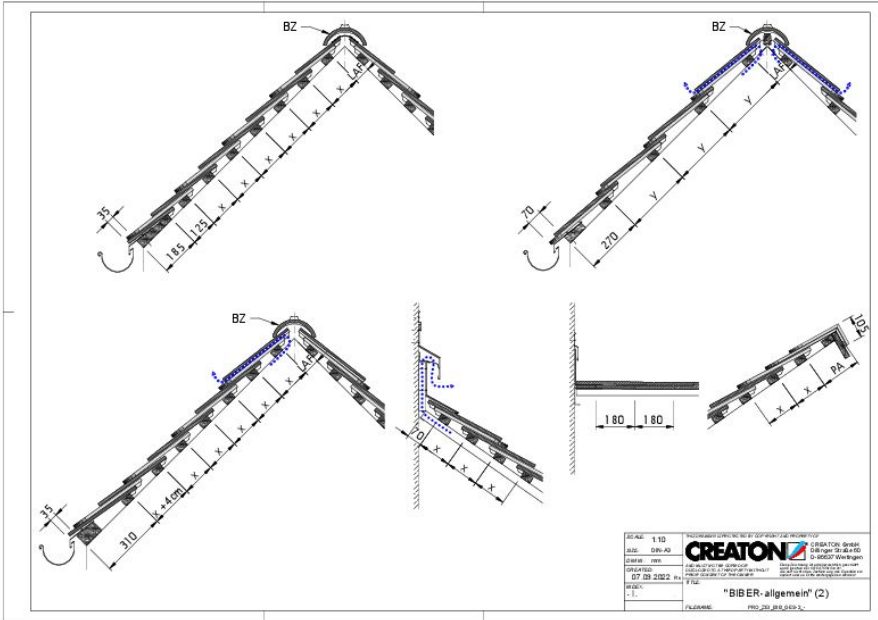

Drawing KLASSIK general view GES-2

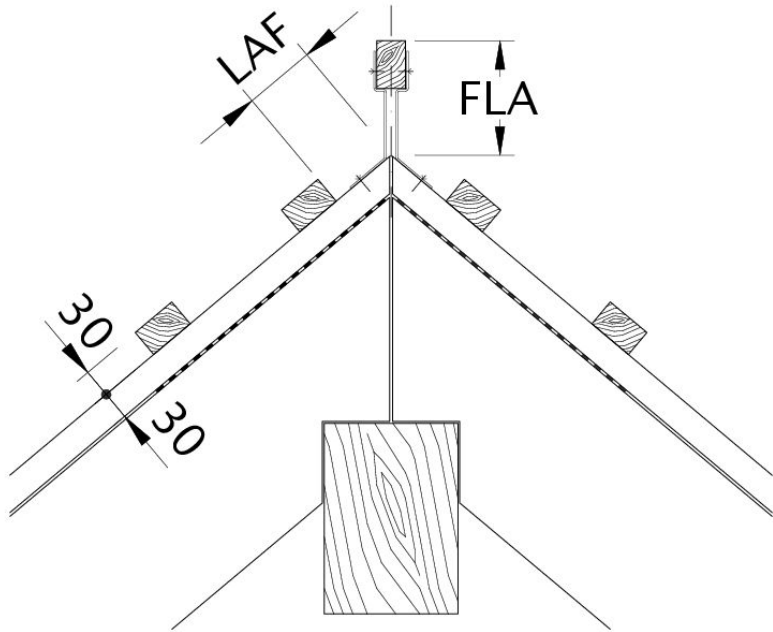

Tehnički crtež proizvoda KLASSIK LAF LAF



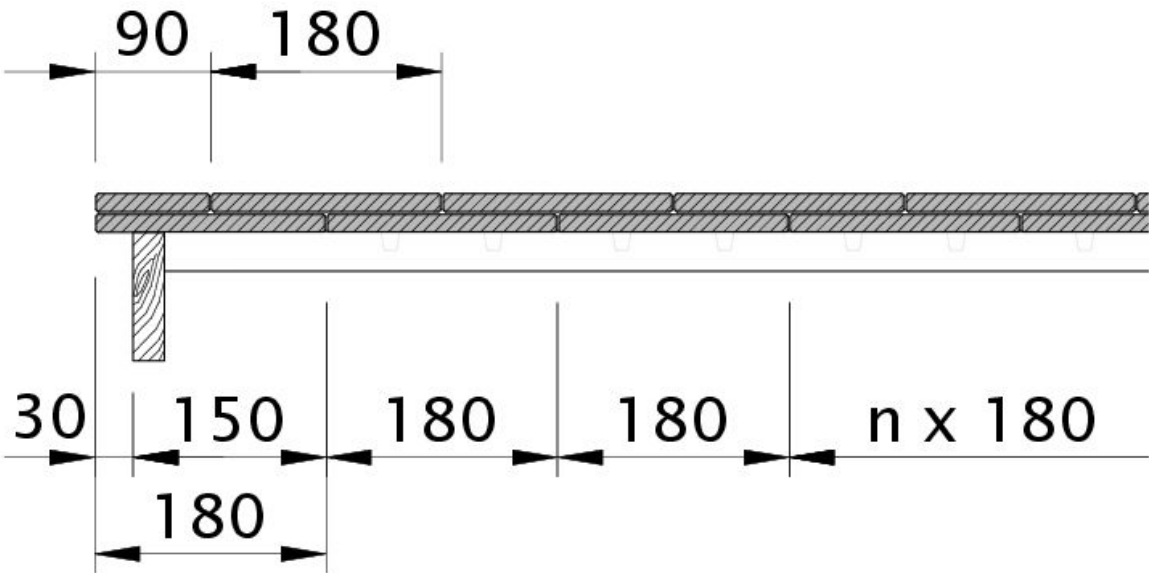

Zeichnung KLASSIK Ortgangziegel links mit Ortgangbrett und 1 1/2 Biber OBL112

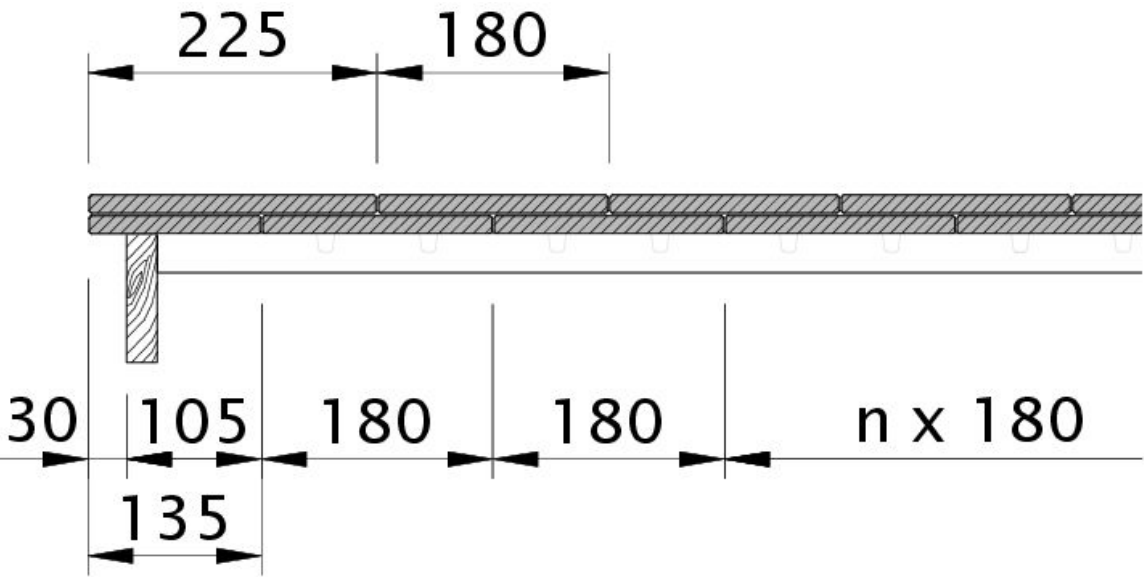

Zeichnung KLASSIK Ortgangziegel links mit Ortgangbrett und 1 1/4 Biber OBL114



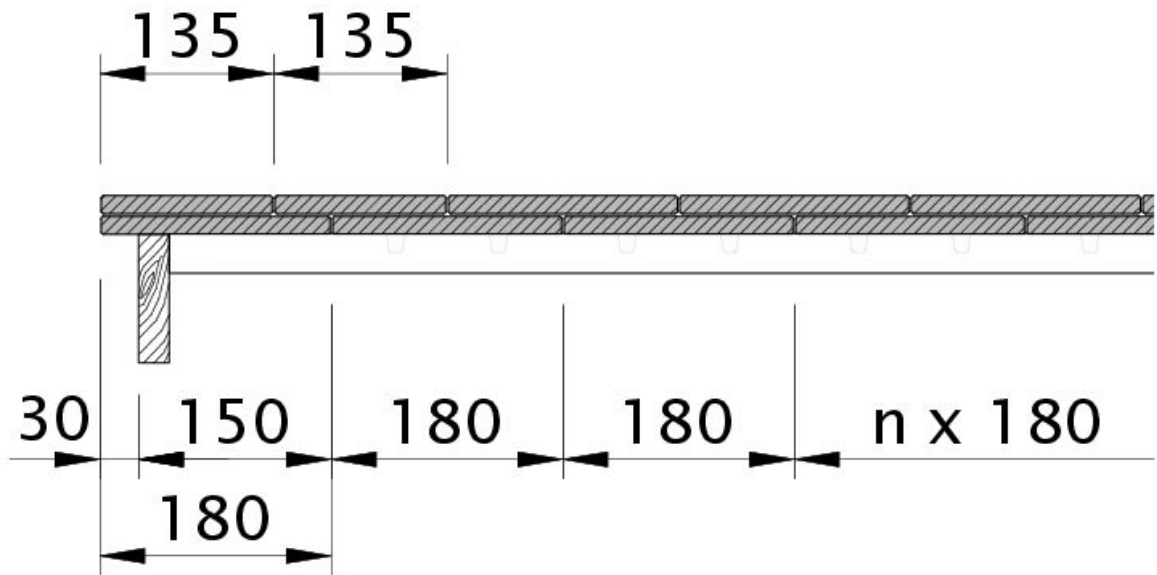

Zeichnung KLASSIK Ortgangziegel links mit Ortgangbrett und 2 3/4 Biber OBL234

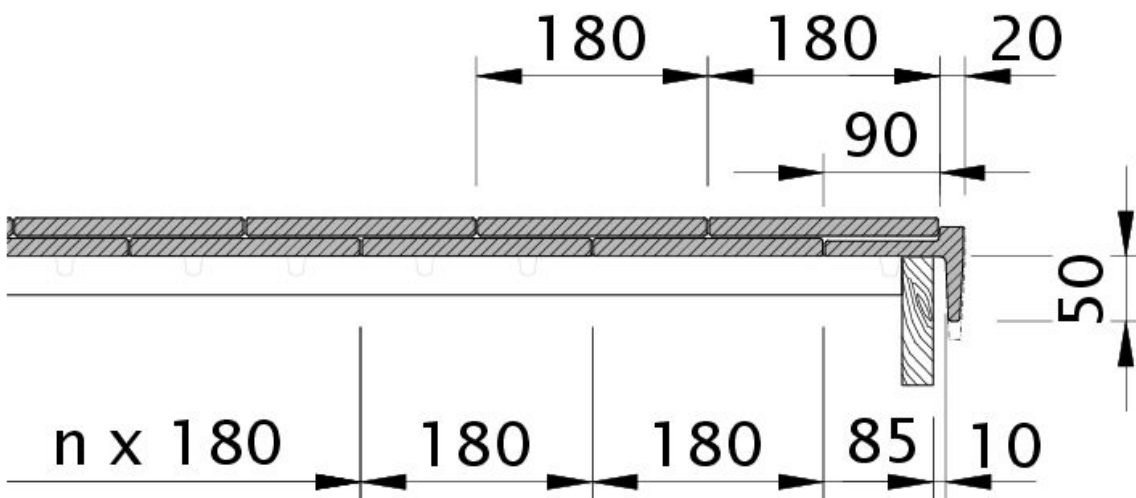

Tehnički crtež proizvoda KLASSIK OBR OBRSCH



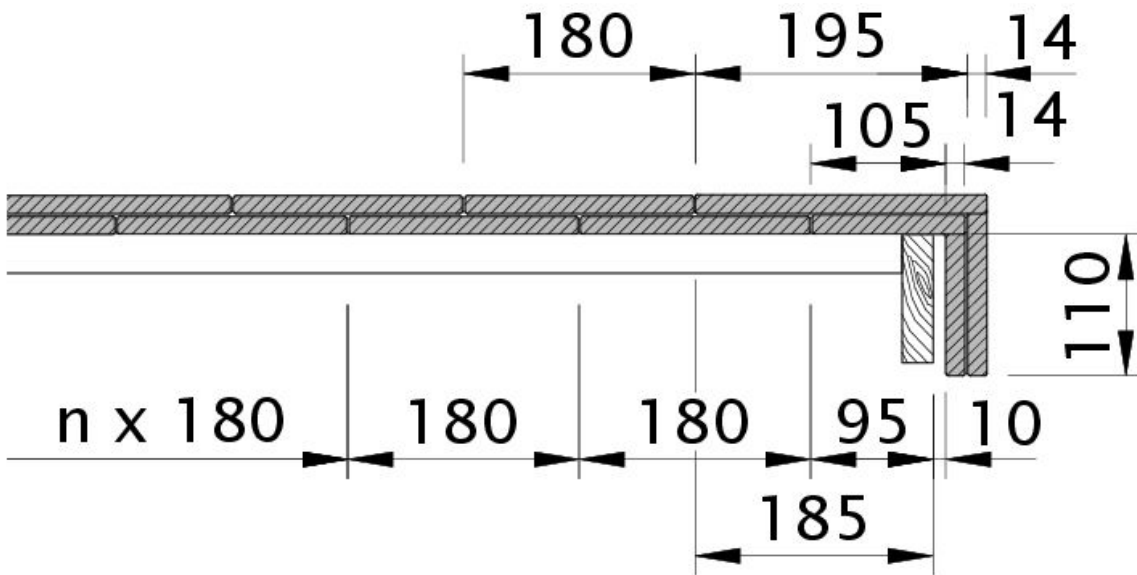

Tehnički crtež proizvoda KLASSIK OBR OBR

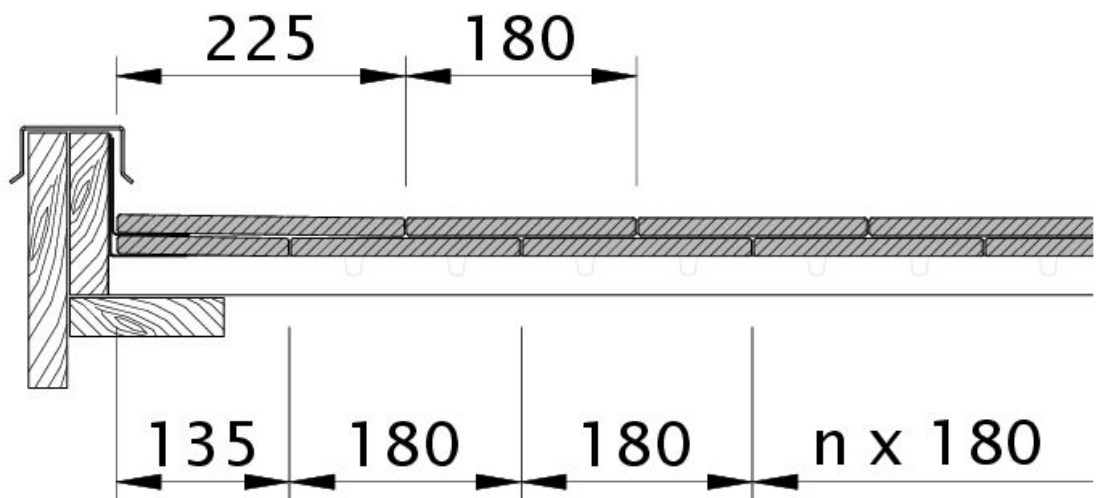

Zeichnung KLASSIK Ortgang links mit Wandanschluss OGLWA



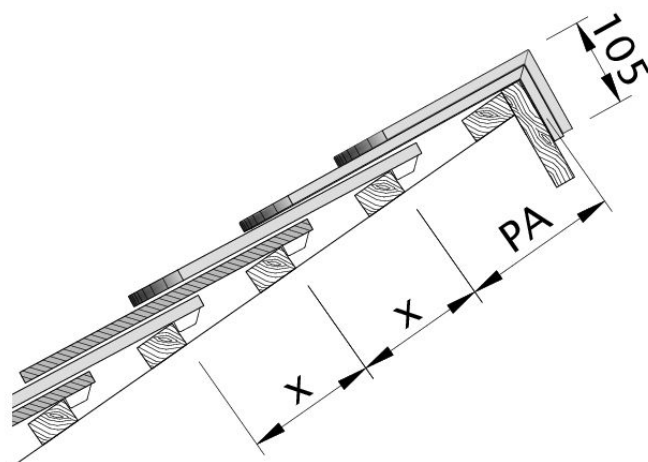

Tehnički crtež proizvoda KLASSIK PDA PDA

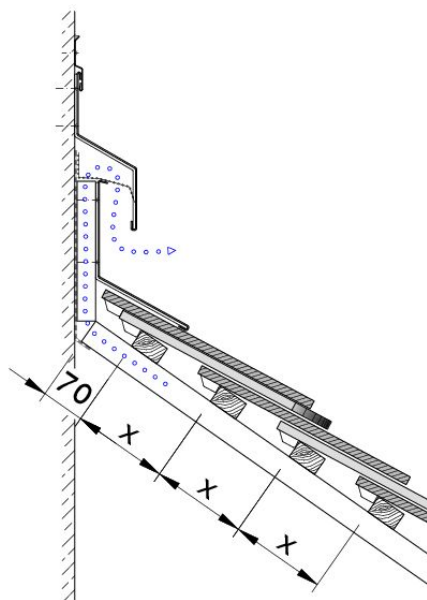

Tehnički crtež proizvoda KLASSIK WMF WMF-1



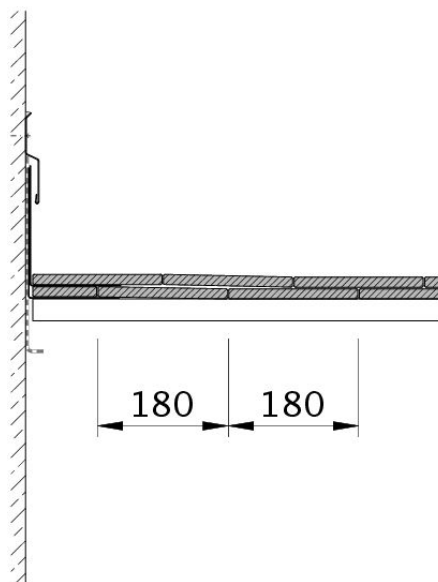

Tehnički crtež proizvoda KLASSIK WMF WMF-2

